

## Infrared Spiral Wound Radiation Source JSIR450-R

Powerful radiation source with circular homogeneous temperature distribution for use with thermopiles and pyro-electric detectors in NDIR gas analysis and other applications.

Spectral Output Range <sup>1</sup>	typ. 0.8 ... 15	µm
Active Area	2.2 dia	mm <sup>2</sup>
Hot Resistant	12±1	Ω
Time Constant	typ. 530	ms
Nominal Power Consumption	0.7	W
Operation Voltage <sup>2</sup>	typ. 2.9	V
Operation Current <sup>2</sup>	typ. 242	mA
Active Area Temperature <sup>3,4</sup>	650	°C
Filling Gas	-	
Filter	-	
Mass	~2	g
Housing	T039 (modified)	
Lifetime	> 50,000 h at 650 °C	

<sup>1</sup> without window

<sup>2</sup> with 12Ω

<sup>3</sup> at nominal power (0.7W)

<sup>4</sup> at T<sub>amb</sub> = 25 °C

The current data are based on simulations and tests. They are subject to change during the next evaluation steps.

September 27<sup>th</sup> 2012 – subject to change without notice

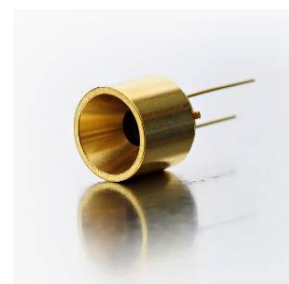

### Pin Assignment

Bottom View

Pin 1 Power  
Pin 2 Power

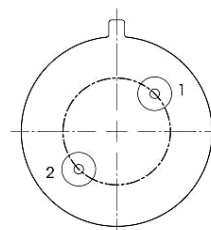

### Absolute Max. Ratings

Power	1.7	W
Housing temperature	200	°C

### Ordering Information

JSIR450-R

6350.11-3.01

**Micro-Hybrid Electronic GmbH**

Heinrich-Hertz-Straße 8  
D-07629 Hermsdorf

Tel.: +49 366 01 592 100  
Fax: +49 366 01 592 110

Email: [Infrared@micro-hybrid.de](mailto:Infrared@micro-hybrid.de)  
Web: [www.micro-hybrid.de](http://www.micro-hybrid.de)

**LIVING MICROWORLDS.**

# Infrared Spiral Wound Radiation Source JSIR450-R

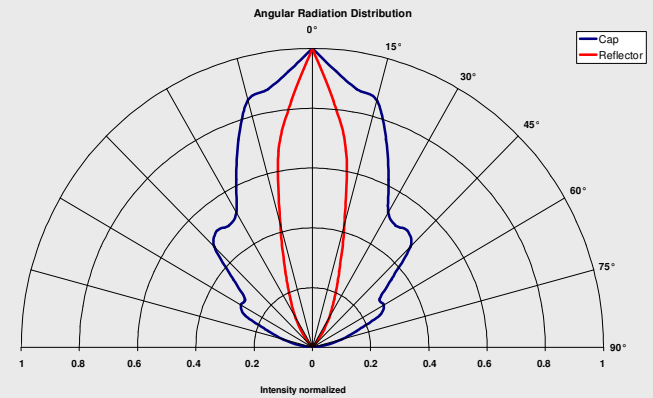
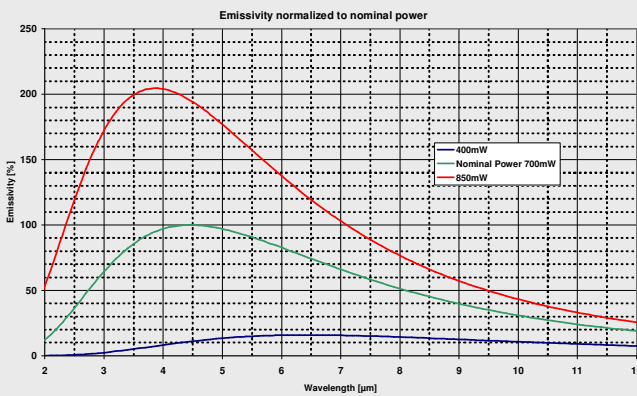
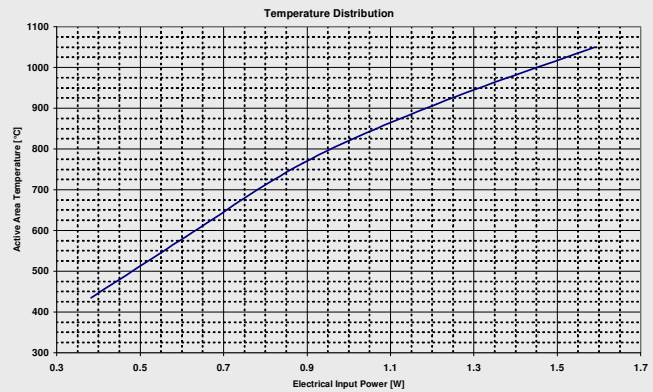
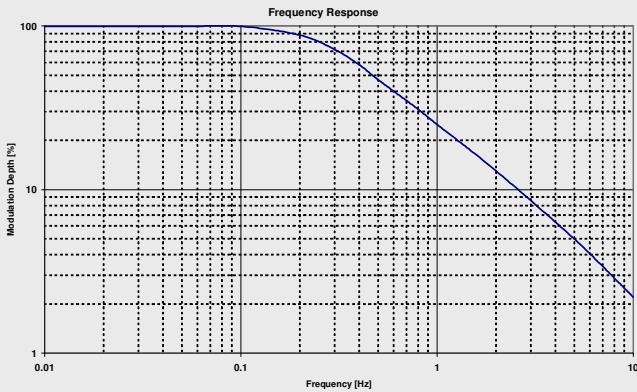

## Housing

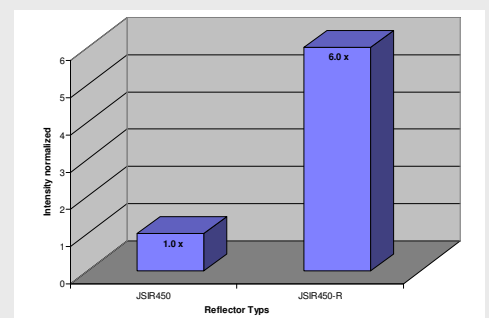
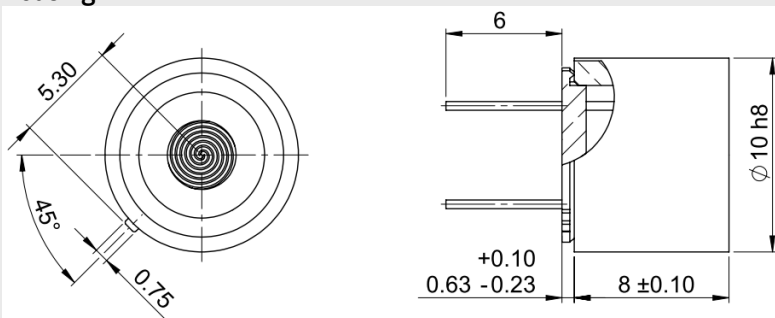

## Optional parts

IR-Detector PS2x4V1- Pyroelectric dual-channel voltage mode detector CO<sub>2</sub>/Ref  
Art.-Nr. 4594.56-H.02

Evaluation Kit - For independent evaluation of emitters and detectors  
Art.-Nr. 7206.01-A.00

**Micro-Hybrid Electronic GmbH**

**Heinrich-Hertz-Straße 8  
D-07629 Hermsdorf**

**Tel.: +49 366 01 592 100  
Fax: +49 366 01 592 110**

**Email: [Infrared@micro-hybrid.de](mailto:Infrared@micro-hybrid.de)  
Web: [www.micro-hybrid.de](http://www.micro-hybrid.de)**

**LIVING MICROWORLDS.**